

## Reference material

# Advanced train control Migration System (AMS) Specifications – Cascading Cases – Application Example

*This document is published as reference material to support the implementation of Automatic Train Protection as part of the roll out of the Advanced Train Control Migration System project.*

*The content described might be of assistance to individuals and organisations performing work on Transport for NSW Rail Assets.*

*When reading this document, any inconsistencies with Transport for NSW Network Standards shall be raised with the Asset Standards Authority (ASA) for clarification.*

*This document does not comply with accessibility requirements (WCAG 2.0). If you are having trouble accessing information in these documents, please contact the [ASA](#).*

Authorised by: Chief Engineer, Asset Standards Authority  
Published: December 2017

### Important message

This document is developed solely and specifically for use on the rail network owned or managed by the NSW Government and its agencies. It is not suitable for any other purpose. You must not use or adapt it or rely upon it in any way unless you are authorised in writing to do so by a relevant NSW Government agency.

If this document forms part of a contract with, or is a condition of approval by, a NSW Government agency, use of the document is subject to the terms of the contract or approval.

This document is published for information only and its content may not be current.



Reference material only

## AMS Project Specification: Cascading Cases – Application Example

DeskSite Reference: DS#5111745

Guideline – Applicable to Transport Projects AMS Program

### Quality Management System

Status:	Issued
Version:	2.0
Branch:	Infrastructure and Services
Business unit:	ATP / AMS Program
Date of issue:	12 May 2017
Review date:	12 May 2017
Audience:	<b>ATP / AMS Project Specific Document</b>
Asset classes:	<input checked="" type="checkbox"/> Heavy Rail; <input type="checkbox"/> Light Rail; <input type="checkbox"/> Multi Sites; <input checked="" type="checkbox"/> Systems; <input checked="" type="checkbox"/> Fleets
Project type:	Major
Project lifecycle:	<input checked="" type="checkbox"/> Feasibility; <input checked="" type="checkbox"/> Scoping; <input checked="" type="checkbox"/> Definition; <input checked="" type="checkbox"/> Construction readiness; <input checked="" type="checkbox"/> Implementation; <input checked="" type="checkbox"/> Finalisation; <input type="checkbox"/> Not applicable
Process owner:	Project Director



Document Approval:

Reference material only

<b>Authored by:</b> Jonna Paw - Signal Design Engineer		<b>Date:</b> 12/05/2017
<b>Reviewed by:</b> Cyril Chéreau - Technical Manager		<b>Date:</b> 12/05/2017
<b>Reviewed and Accepted by:</b> Frederic Tricoche - Principle Engineering Manager (Systems)		<b>Date:</b> 12/05/17
<b>Reviewed and Accepted by:</b> Michael Little - Safety Assurance Manager		<b>Date:</b> 12-5-2017
<b>Reviewed and Accepted by:</b> Nicholas Herb - Manager Operational Integration		<b>Date:</b> 12/5/2017
<b>Approved for Release by:</b> Craig Southward - Project Director ATP		<b>Date:</b> 15/6/17

**Document History**

Version	Date of Issue	Author	Summary of change
0.1	05/02/2016	C.Oxborrow	Initial Draft
0.2	21/03/2016	C.Oxborrow	Second Draft
0.3	08/04/2016	C.Oxborrow	Reviewed
0.4	28/04/2016	C.Oxborrow	Reviewed
1.0	05/05/2016	C.Oxborrow	Reviewed Issued for Approval
1.1	03/11/2016	J.Paw	Updated to align with latest versions of principles and guidelines: -AMS Signal Design Principles v3.0 -AMS Trackside Design Guideline v2.0 -Baseline Arrangement for High Risk Location Design Guideline v3.0
1.2	11/05/2017	J.Paw	Updated to address the review comments
2.0	12/05/2017	J.Paw	Issued for Approval

Reference material only

## Foreword

This document specifically provides examples of application for the implementation of ATP / AMS on the TfNSW heavy rail network, particularly where there are cases of cascading AMS requirements.

To gain a complete overview of ATP / AMS signalling design requirements, this document should be read in conjunction with the AMS suite of signalling design principle and guideline modules.

Reference material only

## Contents

1.	<b>Introduction</b> .....	6
2.	<b>Purpose</b> .....	6
	2.1. Scope.....	6
	2.2. Application.....	6
3.	<b>Reference Documents</b> .....	6
4.	<b>Terms and definitions</b> .....	6
5.	<b>Concept</b> .....	7
6.	<b>Balise Group Functions</b> .....	9
7.	<b>Tolerances</b> .....	10
8.	<b>Combining functions</b> .....	10
	8.1. Calibration exceptions .....	11
	8.2. Repositioning Execution exceptions .....	11
	8.3. Big Metal Mass exceptions.....	12
9.	<b>Data Appreciation</b> .....	12
10.	<b>Cascading Cases</b> .....	13
	10.1. Speed Signs & Deficient Overlaps.....	13
	10.2. Turnouts & Deficient Overlaps.....	16
	10.3. Bi-directional Signalling and Turnouts .....	24
	10.4. Wrong Running Entry/Exit, Level Crossings and Turnouts .....	25
	10.5. Converging Junctions .....	26
	10.6. Speed Signs and Turnouts .....	27
11.	<b>Examples of AMS Layouts</b> .....	28
	11.1. Hornsby.....	28
	11.2. Leppington .....	32

Reference material only

## 1. Introduction

AMS will require balises to be installed in the four foot of the track. Each AMS function will require one or more balises. In some circumstances it will be possible that the number of installed balises can be reduced by combining functions.

In some layouts, one particular AMS function follows another particular AMS function, and this cascading effect can affect the number and positioning of the required balises.

## 2. Purpose

### 2.1. Scope

This document gives guidance on which balise group functions can be combined.

Guidance is given on cascading AMS functions. Examples are provided on how to apply basic AMS principles.

### 2.2. Application

This document applies to AEOs engaged to carry out the design of AMS layouts on signalling plans.

## 3. Reference Documents

[Ref 1] AMS Trackside Subsystem Requirements

[Ref 2] AMS Signal Design Principles

[Ref 3] AMS Approach Balise Group Selection and Positioning Design Guideline

[Ref 4] AMS Balise Arrangement for High Risk Location Design Guideline

[Ref 5] AMS Circuit Design Standard

[Ref 6] AMS Trackside Design Guideline

## 4. Terms and definitions

The following terms and definitions apply in this document:

**AEO** Authorised engineering organisation; means a legal entity (which may include a Transport Agency as applicable) to whom the ASA has issued an ASA Authorisation

**AMS** Advanced train control Migration System

**ASA** Asset Standards Authority

**BG** Balise Group

**Cascading Functions** More than one AMS function in the same vicinity where one function affects another

**Combined Function** More than one AMS function that can be implemented by using just one balise group

**ETCS** European train control system; a three level, unified, modular automatic train protection specification to enhance interoperability across Europe

**LS** Limited Supervision

**LSSMA** Lowest Supervised Speed within the Movement Authority

**MA** Movement Authority

**Permitted Point** where a train needs to start braking to avoid a speed warning being displayed on a DMI

**SPA** Special Proceed Authority

**SR** Staff Responsible

**SSP** Static Speed Profile

**TfNSW** Transport for New South Wales

**TSM** Target Speed Monitoring

**TSR** Temporary Speed Restriction

## 5. **Concept**

The AMS on-board system communicates with the AMS trackside system by way of balises installed in the 4-foot. Balises are usually installed as part of a 'balise group' (BG), typically consisting of two balises, separated by the preferred minimum distance of 2.3m. By having more

Reference material only



than one balise in a group allows directional capabilities, which enables the on-board system to only act upon the information it receives that is valid for the applicable direction.

Single balises are only used in the instances where train odometer calibration is required or where one is required for a buffer stop. Single balises are termed single balise groups. Balise groups consisting of more than two balises may occur where the volume of data to be transmitted to the on-board system is too large for the typical arrangement.

Balises are required for a number of different functions. It is beneficial to minimise the number of balises installed. When designing the balise layout for a given area, one should thus attempt to combine more than one function into a BG, whilst still complying with the requirements and tolerances stated in the AMS project specifications.

Some layouts will have cascading functions, for example a high risk speed reduction followed by a high risk turnout. In these situations, individual assessment of each risk is required to see if protecting one removes the need to protect the other, or whether both risks need to be protected.

Balises can be defined as either 'controlled' or 'fixed'. The data sent by a controlled balise varies depending on the information it receives from a lineside electronic unit (LEU). The LEU receives its information from a wired interface with the signalling system. The data sent by a fixed balise does not change once it is programmed. For the purpose of this document, a fixed balise is depicted as a hollow triangle; a controlled balise is depicted as a solid triangle.

Balise groups can also be defined as either 'controlled' or 'fixed'. A controlled BG has at least one controlled balise; it typically has a controlled balise followed by a fixed balise. A fixed BG only has fixed balises; it typically consists of two fixed balises.

Reference material only

## 6. Balise Group Functions

The following table is a list of BG functions and sub-functions for AMS.

Function / Sub-function	BG Type	TSM	Principles [Ref 2] Section Reference
ETCS Trainstop e.g. For a signal without a conventional trainstop.	Controlled	-	12
ETCS Trainstop e.g. For a fixed red signal without a conventional trainstop, and the trainstop needs suppression.	Fixed	-	6.1.2, 12.2, 12.3.3
High risk turnout (TSM initiating)	Controlled	TSM	13
High risk deficient overlap, catch point or level crossing (TSM initiating)	Controlled	TSM	14, 15, 16
Toggle off LSSMA for high risk deficient overlap, catch point or level crossing.	Fixed	-	7.4.2, 14.2.3
Speed sign – low risk and high risk	Fixed	-	7.4.3, 11
The BG marked as linked (excluding calibration balise) in rear of a high risk speed sign	as per primary	TSM	11.3
High risk speed sign approach, needed in certain cascading layouts only, such as Figure 25.	Fixed	TSM	-
High risk speed sign, high risk turnout, buffer stop, end of line, deficient overlap, catch point or level crossing announcement, needed for redundancy	as per primary	-	11.3, 13.3.1, 14.2.3 17.2.1
First repositioning announcement	as per primary	-	7.4.11, 7.6
Second repositioning announcement	as per primary	-	7.4.11, 7.6
Repositioning execution	Fixed	-	7.4.2, 7.4.11, 7.6
Speed update after traversing a turnout – low risk and high risk	Fixed	-	7.4.2, 13.3.2, 13.4.1
Wrong running entry	Fixed	-	7.4.9, 9.6.1
Wrong running exit	Fixed	-	7.4.9, 9.6.1
Buffer stop (or end of line) approach	Fixed	TSM	17.2
Buffer stop (or end of line): - where distance from operational stopping location is ≤ 10m	Fixed (single)	-	17.2
Buffer stop (or end of line): - where distance from operational stopping location is > 10m	Fixed	-	17.2
Terminating platform with end of line - with possible overrun on arrival, then setback	Fixed	-	17.2
Terminating platform: Mode Change	Fixed	-	7.4.10

Reference material only

- for resuming LS mode after a turnback			
Yard entry announcement / second yard exit	Fixed	-	21
Yard entry execution / first yard exit	Fixed	-	21
First announcement of wrong running hazard (i.e. level crossing)	Fixed	TSM	9.6.2
Second announcement of wrong running hazard (i.e. level crossing)	Fixed	TSM	9.6.2
Level transition announcement	Fixed	-	18.3
Level transition border	Fixed	-	18.3
Approach – on approach to, or at TSM protecting signal	Controlled	-	13.3.2, 14.2.3, 20.3
Approach – at intermediate signals	Controlled	-	20.3
Big Metal Mass announcement	Fixed	-	19.2
Calibration	Fixed (single)	-	11.3.1

It can be seen that some BG functions are always combined with another function. For example, a repositioning announcement BG is always combined with a BG that already has its own primary purpose.

In the table above, TSM indicates which BG functions are used for initiating Target Speed Monitoring. TSM is the supervision type where a train brakes to a target speed and position. The TSM target speed needs to be provided twice; the second is at a BG for initiating TSM. The first is at an additional BG in rear, for redundancy purposes in case the initiating BG is missed.

## 7. Tolerances

The AMS Signal Design Principles define balise placement tolerances where required to allow for site conditions. In general, these tolerances can also be applied if it allows the combining of more than one BG function, thus saving the installation of a balise group.

Refer to the AMS Signal Design Principles [Ref 2] for more details.

## 8. Combining functions

It is possible to combine many different functions in balise groups. When combining a ‘controlled’ BG function with a ‘fixed’ BG function, then the resulting BG will be ‘controlled’.

In some instances, combining two functions may result in the balise group requiring three balises, due to maximum data constraints. This is still preferable to having two groups of two.

There are combinations that simply can never happen, due to the placement in the layout. For example, a wrong running entry BG would never be near the vicinity of a buffer stop BG.

Reference material only

Notwithstanding this, nearly every balise group function can be combined with nearly every other balise group function. Some of the exceptions are listed in the following sub-sections.

### 8.1. Calibration exceptions

Calibration balises are a dedicated single balise, used to reset the confidence interval of a train's odometer, such that undue early braking is avoided during TSM. They are needed when there are no other balises nearby, as described in the AMS Balise Arrangement for High Risk Location Design Guideline [Ref 4].

For AMS, a dedicated calibration balise will not be combined with any other BG function.

Note that the ERA braking curve tool spreadsheet uses the term 'relocation balise'. All linked balises can be considered as relocation balises as they all will reset the confidence interval.

### 8.2. Repositioning Execution exceptions

A repositioning execution BG must not be combined with any BG used for initiating TSM in the same direction. For example, with reference to Figure 16, it wouldn't be possible to combine the functions from BG3 and BG4.

The reasons are as follows:

- a) With them combined, if a train enters SR mode whilst between the redundant TSM BG and the initiating TSM BG, then the train will remain in SR mode after passing the initiating TSM BG, with no TSM applied.
- b) With them combined, the redundant TSM BG is in rear of the diverging turnout, potentially initiating TSM for a movement through the points in the other lie. If we chose not to provide a redundant TSM BG, then a braking linking reaction would be needed instead, which is not in line with operational desires. If we chose to do neither, then missing the initiating TSM balise group would prevent TSM being applied when required.

Note however that a repositioning execution BG may be used for transmitting the redundant TSM information, as BG3 does in Figure 16.

Reference material only

As a balise group containing a Movement Authority (MA) cannot contain repositioning information for the same direction, it means that any BG used for executing repositioning cannot also be used to transition from SR mode to LS mode in the same direction.

Thus RE functions cannot be combined with the following BG functions:

- High risk turnout (TSM initiating), in the same direction
- High risk deficient overlap, catch point or level crossing (TSM initiating), in the same direction
- High risk speed reduction (TSM initiating), in the same direction
- Buffer stop/end of line (TSM initiating and Redundant TSM), in the same direction
- Resume LS mode after a turnback, in the same direction
- Calibration.

### 8.3. Big Metal Mass exceptions

A Big Metal Mass announcement BG cannot be used for any other AMS function.

## 9. Data Appreciation

For positioning balises on certain layouts, it is necessary to have an appreciation of the data transmitted by balises. A balise group sends a message, comprising of a telegram from each balise. A telegram is comprised of packets. Each packet has a number and a specific function. For example, packet #21 contains the gradient profile of the track ahead, and packet #27 contains the 'Static Speed Profile' (SSP), e.g. the line speed. This SSP packet is also able to contain information for line speed changes ahead, with the distance to them. Each one of these speeds (with distance) is termed an 'iteration'. If the on-board system receives a second SSP iteration with a lower speed than the first, then it calculates a braking curve such that the reduction in speed is monitored up to the target point, with applicable braking interventions if necessary. This is termed Target Speed Monitoring (TSM). In the diagrams that follow, the TSM braking curve for the protected AMS function is shown as the blue or green line, with the line speed shown as the red line.

Reference material only

## 10. Cascading Cases

### 10.1. Speed Signs & Deficient Overlaps

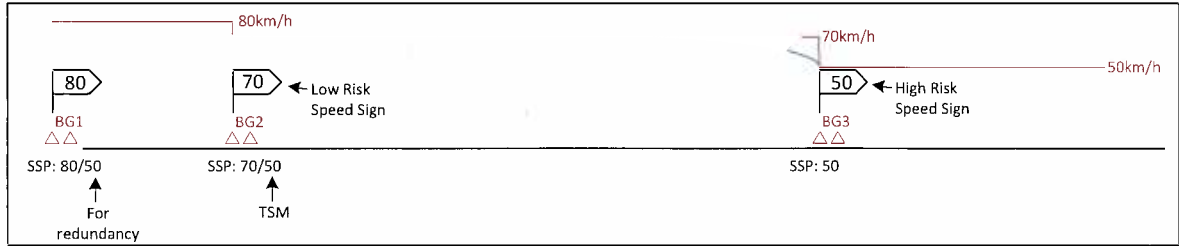

Figure 1

Figure 1 shows the standard arrangement for protecting a high risk speed sign with AMS.

The SSP from BG2 has two iterations, with the second iteration of 50km/h initiating TSM.

BG1 includes 50km/h in its second iteration to provide redundancy in case BG2 is missed. Note that it doesn't include 70km/h as its second iteration, as the 70km/h speed sign is a deemed low risk.

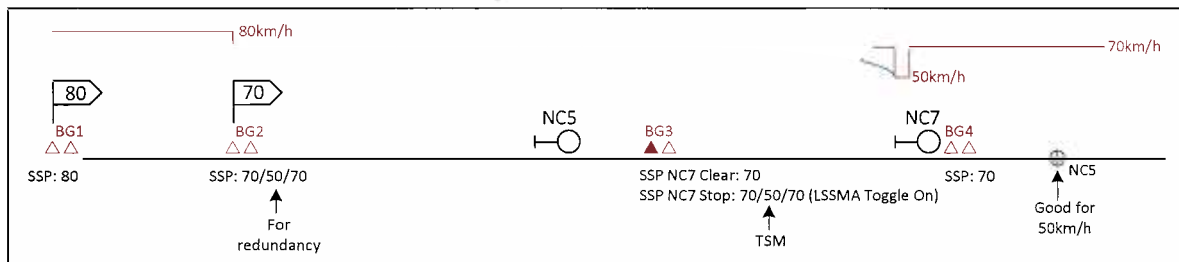

Figure 2

Figure 2 shows the standard arrangement for protecting a deficient overlap with AMS. If signal NC7 is clear, then the static speed profile (SSP) transmitted by BG3 is simply a single iteration of 70km/h. If NC7 is at stop, then the SSP has three iterations, with the second iteration of 50km/h initiating target speed monitoring, and the third iteration bringing the permitted speed back up to line speed.

BG2 includes 50km/h in its second iteration to provide redundancy in case BG3 is missed.

BG1 is a standard speed sign balise group, with a simple single iteration of 80km/h.

BG4 is needed for toggling off the 'lowest supervised speed within the movement authority' (LSSMA), because it may have been toggled on by BG3.

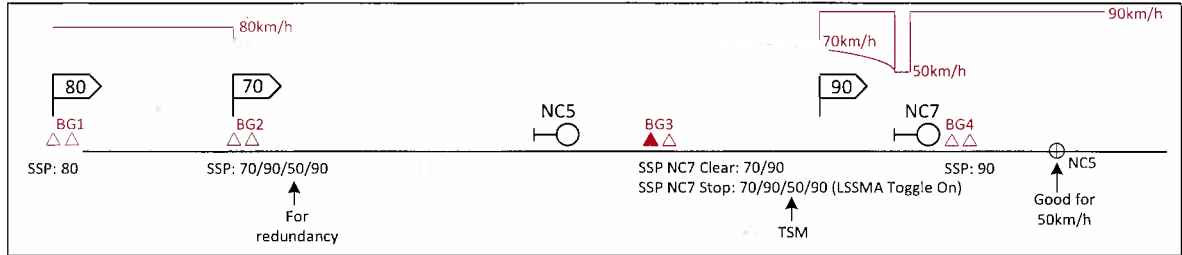

Figure 3

Figure 3 shows a similar arrangement to Figure 2, with the addition of a speed sign (90km/h) between BG3 and NC7. Note that this speed sign cannot have its own balise group, because it would be a fixed balise group, and the SSP transmitted by it would always be "90", which would overwrite the third iteration "50" transmitted by BG3 if NC7 was at stop. Instead, BG3 (and BG2) will transmit the "90" by an iteration.

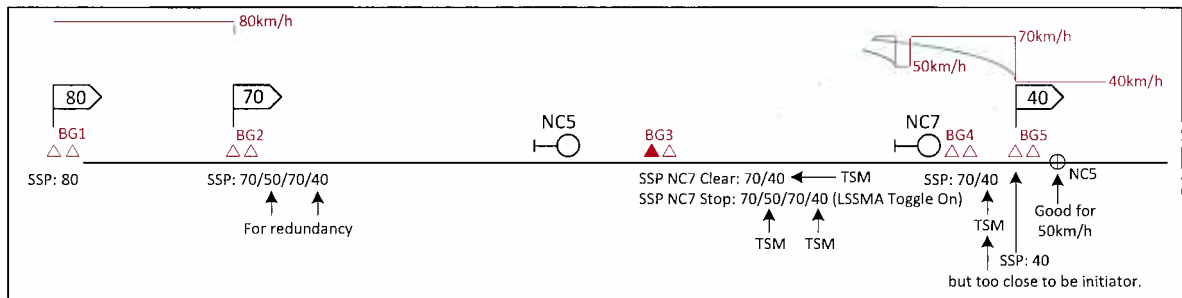

Figure 4

Figure 4 shows an arrangement with a deficient overlap followed by a high risk speed sign. Contrasting with Figure 3, this high risk speed sign is not in the TSM area between BG3 and signal NC7, thus it has its own speed sign balise group, BG5.

BG4 (whose primary purpose is to toggle off the LSSMA) is too close to the high risk speed sign to be the main initiator of TSM; nevertheless, it requires 40km/h as a second iteration.

BG3 has two main purposes; it initiates TSM for the 40km/h high risk speed sign, and it initiates TSM for the deficient overlap when NC7 is at stop.

BG2 includes redundancy for both TSM functions.

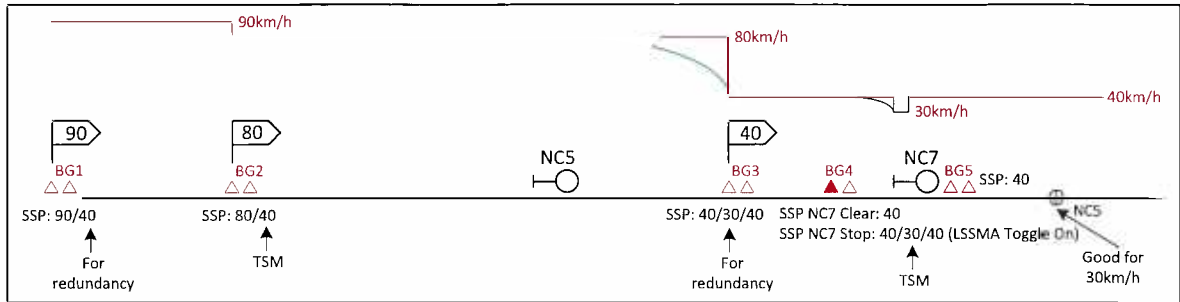

Figure 5

Figure 5 shows an arrangement with a high risk speed sign (40km/h) followed by a deficient overlap. The braking point for the deficient overlap is closer to signal NC7 than the speed sign is, so each will have a balise group. An alternative solution to this (if site conditions allow) would be to combine the functions in BG3 and BG4, as shown in Figure 6 below.

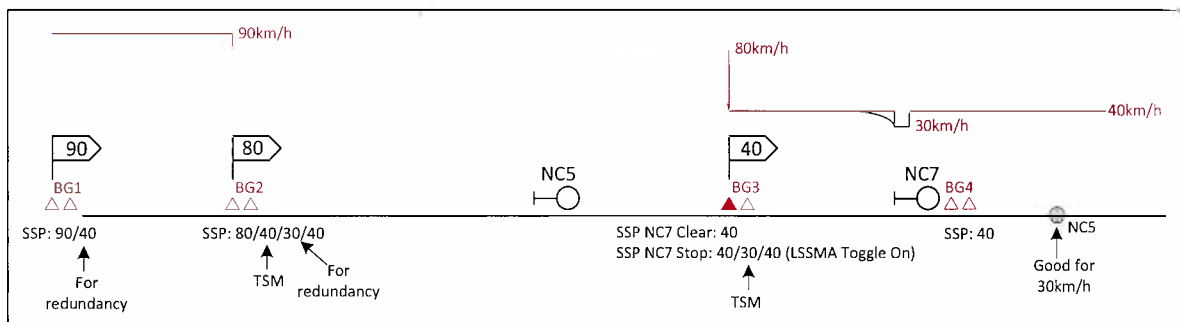

Figure 6

Figure 6 is as per Figure 5, with BG3 having two purposes; it is a speed sign balise group, and it initiates TSM for the deficient overlap when signal NC7 is at stop. Note that in deciding whether to combine balise group functions, there is a trade-off between cost and operational benefits; in Figure 6, if signal NC7 clears after the train has passed BG3, then the train speed is supervised to the reduced speed of 30km/h until it has passed the signal, so the closer the balise group to the signal, the better the operational benefits. There could be extra trenching costs running the balise cable from NC7 location to BG3, however there are cost savings in saving a pair of balises.

Reference material only



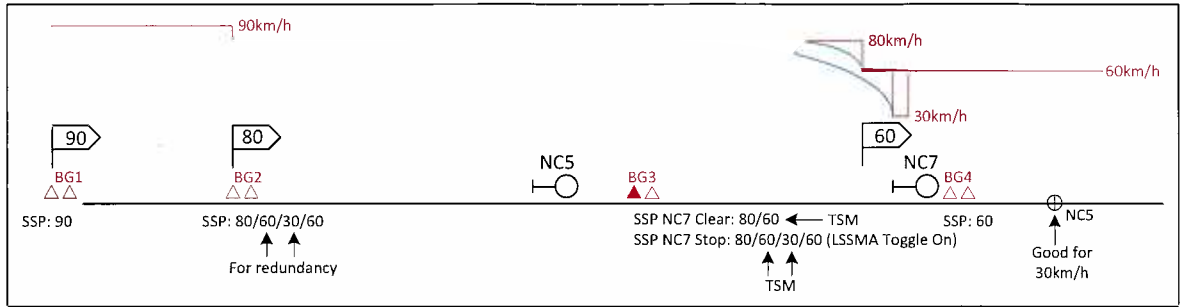

Figure 7

Figure 7 is similar to Figures 5 & 6, however the braking point for the deficient overlap is farther from the signal than the high risk speed sign, thus a balise group is needed on approach to the braking point of the deficient overlap. We end up with a situation similar to Figure 3, where the speed sign is in the TSM area, and thus cannot have its own balise group.

## 10.2. Turnouts & Deficient Overlaps

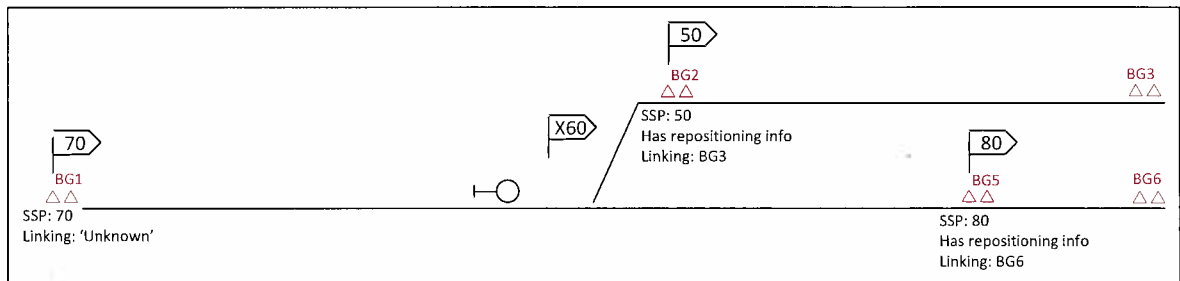

Figure 8

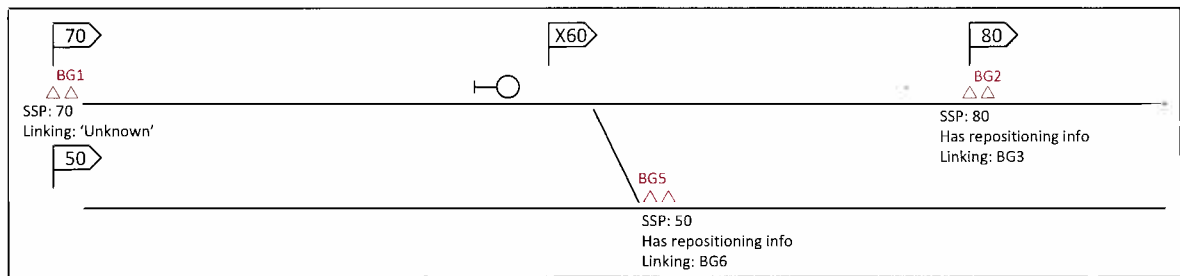

Figure 9

Figure 8 and Figure 9 show a typical low risk turnout and crossover. There is no TSM.

Linking on a straight section of track involves specifying the name of the next balise group. For a facing turnout, it is generally unknown which balise group will be passed over next, thus linking in

Reference material only

this case uses the 'unknown' identifier. In the examples above, BG1 will use this 'unknown' identifier in the linking packet.

BG2 & BG5 have repositioning information. It is important to note that balise groups that have repositioning information cannot also transmit a 'movement authority'. An implication of this is that a train travelling in SR mode (e.g. after a braking intervention) cannot be brought back to LS mode by a repositioning execution balise group.

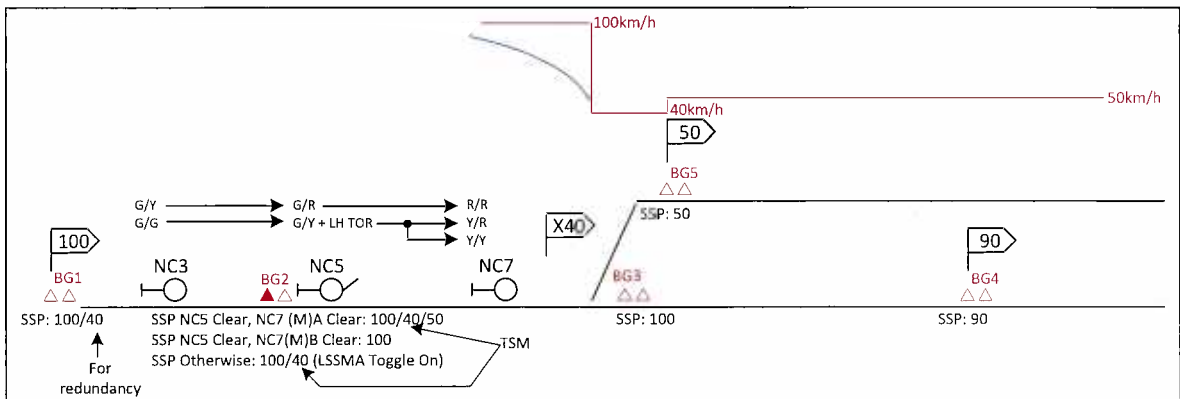

Figure 10

Figure 10 shows a typical high risk turnout. Regardless of whether the route from NC7 is known or not at the time of passing BG2, repositioning is applied as per Figure 9.

BG2 may initiate TSM (depending on NC5 and NC7), so it may toggle on the LSSMA.

BG3 includes an SSP of 100km/h, in case NC7(M)B was not clear at the time of passing BG2. BG3 will also toggle off the LSSMA.

BG5 includes an SSP of 50km/h, and will also toggle off the LSSMA.

Reference material only

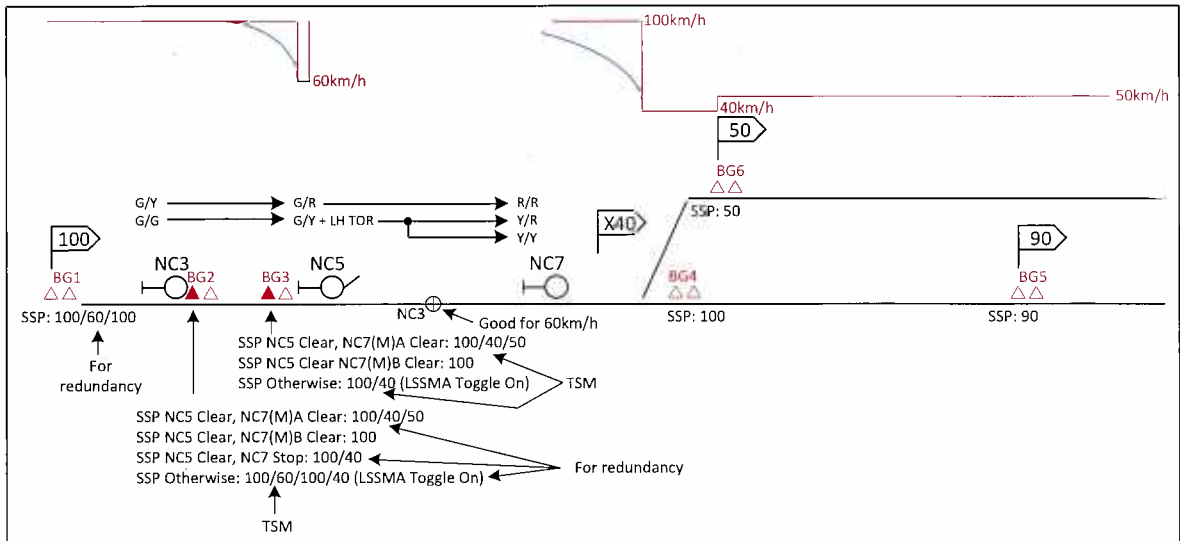

Figure 11

Figure 11 shows a deficient overlap cascaded with the high risk turnout from Figure 10.

The balise placement shown in Figure 11 may not be ideal, as it may be operationally unacceptable, with the reason being as follows.

If a train passed BG2 with NC5 at stop, then it would receive SSP iterations of 100/60/100/40km/h, and LSSMA would be toggled on. The DMI will display the lowest supervised speed within the movement authority, which in this case will be 40km/h, even though it is only being sent for redundancy purposes for a possible TSM initiation farther down the track.

The implication of the DMI displaying 40km/h (instead of the desired 60km/h) is that if signal NC5 clears with the train on approach to it, the driver will be misled into believing that accelerating over 40km/h will result in a warning and a possible brake intervention. That being said, the train would have been approaching NC5 at a reduced speed with the intention to stop when NC5 is at stop. If signal NC5 clears after the train has passed BG2 LSSMA will still continue to display 40km/h but as soon as the train passed BG3, the train will get an update and toggle off the LSSMA if deemed not required.

Reference material only

Reference material only

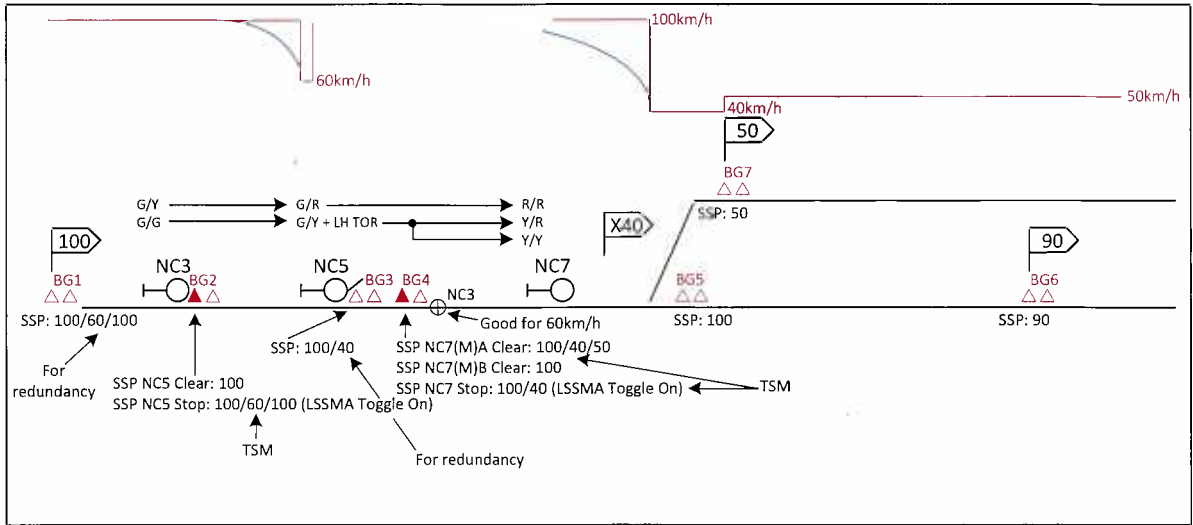

Figure 12

Figure 12 shows a preferred balise arrangement (as it minimises the operational impact), with the same track layout as per Figure 11.

BG3 is a standard fixed balise group for toggling off LSSMA for the deficient overlap. It also contains the redundant 40km/h TSM for the high risk turnout.

BG2 no longer has a combination of SSP speed iterations of TSM and a (lower) redundant TSM.

Note that in choosing the preferred balise arrangement, designers should seek to optimise the solution based on cost and operational benefits. Refer to the AMS Signal Design Principles [Ref 2] and the AMS Approach Balise Group Selection and Positioning Guideline [Ref 3] for more details.

Reference material only

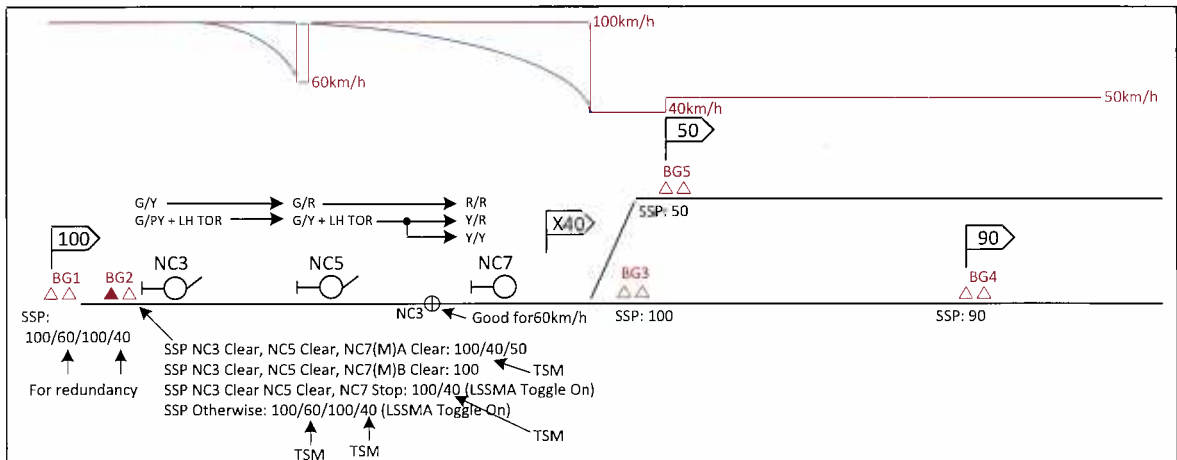

Figure 13

Figure 13 is similar to Figure 11, however the braking for the turnout is longer, with the associated balise group being placed at the preliminary medium signal.

Again, the overlap for NC3 is deficient. The balise group for initiating TSM for the deficient overlap can be combined with the balise group for initiating TSM for the high risk turnout (BG2).

Note that there is no balise group for toggling off LSSMA for the deficient overlap, as it needs to remain toggled on for the high risk turnout.

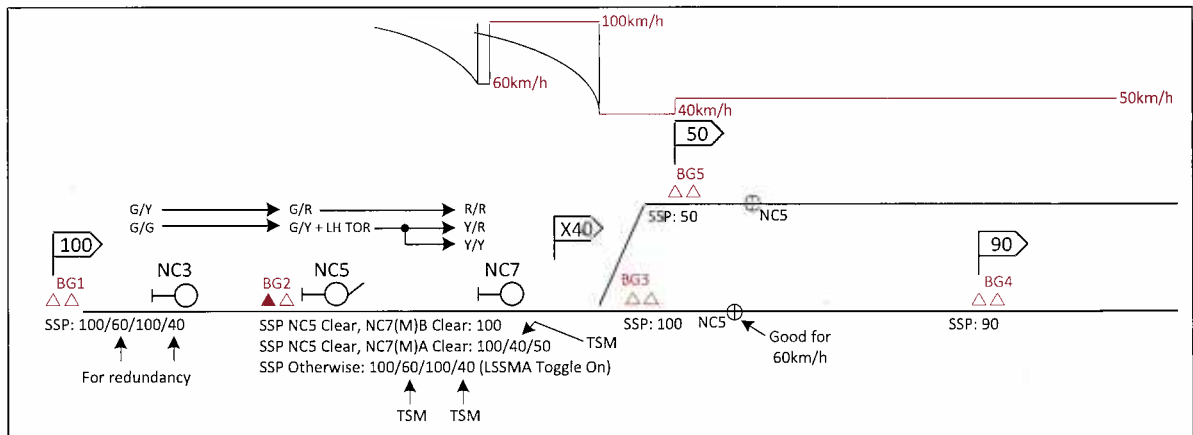

Figure 14

Figure 14 is another permutation of a cascading high risk turnout and deficient overlap. It shows the typical high risk turnout as per Figure 10, with the medium signal having a deficient overlap in advance of the junction signal.

Note that there is no balise group for toggling off LSSMA for the deficient overlap, as it needs to remain toggled on for the high risk turnout.

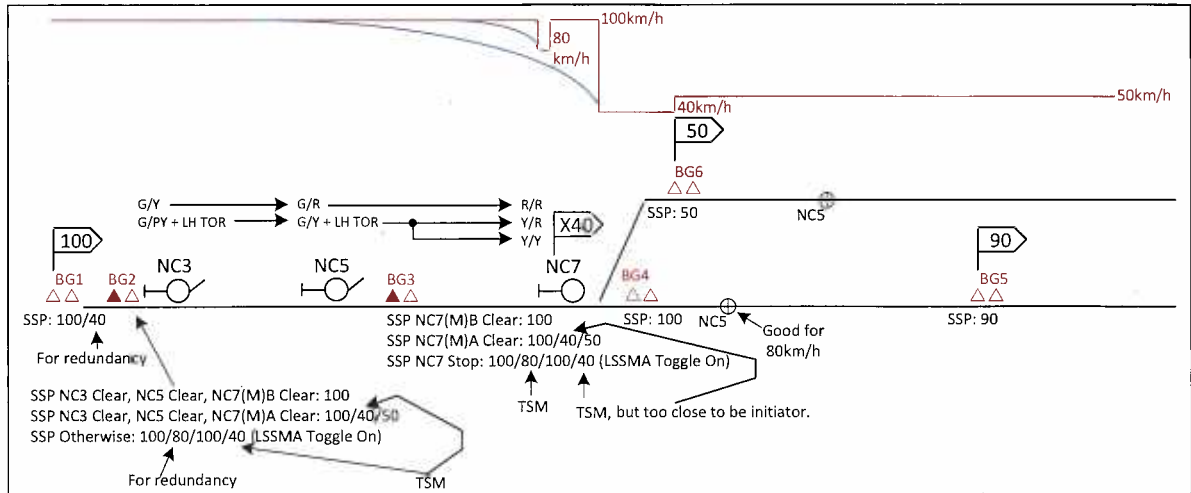

Figure 15

Figure 15 is similar to Figure 13, except signal NC5 has the deficient overlap instead of signal NC3.

BG3 initiates TSM for the deficient overlap if NC7 is at stop.

Note that there is no balise group immediately after NC7 for toggling off LSSMA for the deficient overlap, as it needs to remain toggled on for the high risk turnout. The LSSMA will be toggled off if NC7(M)A or NC7(M)B clears before the train passes BG3.

Note that BG1 does not require 80km/h as a second iteration in the SSP packet, as BG2 is catering for this.

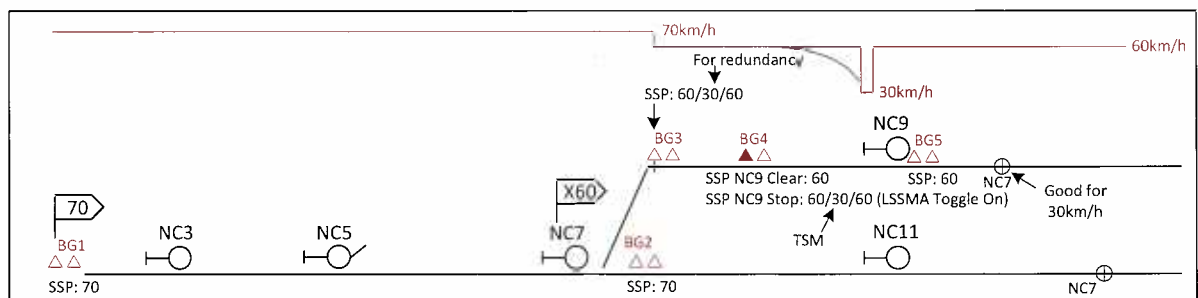

Figure 16

Figure 16 shows a low risk turnout route with a deficient overlap.

Reference material only

Reference material only

BG4 initiates TSM for the deficient overlap.

Note that BG4 is required on the approach side to the braking point from 70km/h to 30km/h as the turnout speed is not enforced.

BG3 contains the redundant TSM, and also executes repositioning.

Note that BG3 cannot be the initiator of TSM, as it is a repositioning balise group.

Note that BG2 is required to execute repositioning, and cannot be placed farther from BG1 than BG4 is (taking into consideration the confidence interval), as that would otherwise place BG4 inside the expectation window for the turnout.

It is worth noting here a certain acceptable failure mode that is not fail safe. BG1 will link to BG2 and BG3, but not to BG4, due to repositioning at the facing junction. So if BG3 and BG4 are missed, then the on-board system will continue to hold a speed profile of 70km/h until the train has passed BG5, and TSM will not be applied with signal NC9 at stop (This is acceptable as it is more than a “single point of failure”).

BG5 is needed for toggling off the LSSMA because it may have been toggled on by BG4.

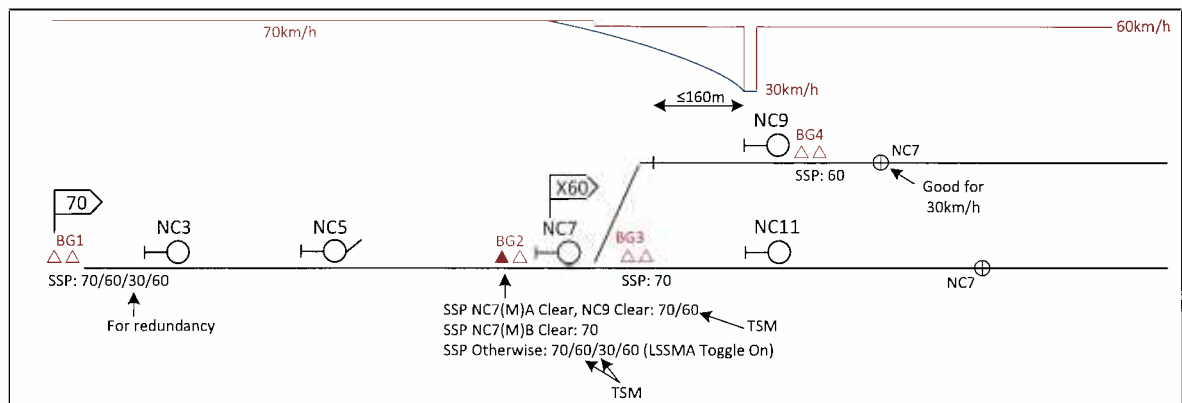

Figure 17

Figure 17 shows a low risk turnout route with a deficient overlap, as per Figure 16, however we now have the TSM initiation point on the main line. TSM will be initiated at BG2, but it must be conditional, as not all trains will be turning out. Thus a controlled balise group is needed at the junction signal. Turnout speed will need to be enforced and LSSMA will need to be applied.

It is not possible to have a (repositioning) balise group on the branch line in rear of signal NC9, as we cannot update the SSP to the new line speed when a TSM braking curve could be being applied.

BG4 toggles LSSMA off. As the distance from the turnout to signal NC9 is less than or equal to 160m, the update of the speed profile when turning out can be achieved by BG4.

BG3 executes repositioning and updates the speed profile. It is close to the turnout to ensure the speed is updated soon after travelling through the points normal, for example when NC7(M)B is used.

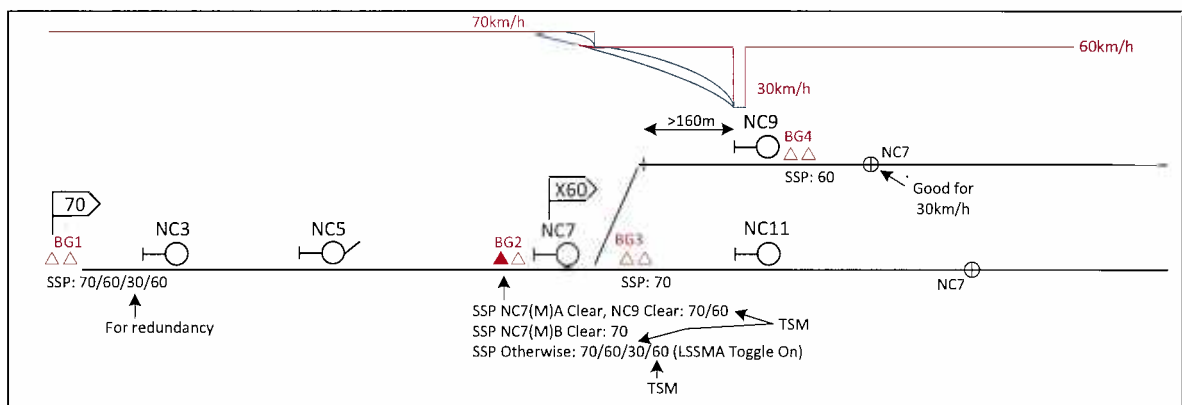

Figure 18

Figure 18 is as per Figure 17, however we now have greater than 160m between the turnout and signal NC9.

If a train is turning out on clear main aspects, the SSP from BG2 needs to include additional iteration (i.e. the line speed applicable to the diverging line), to ensure the on-board system is not told of the updated speed too late. However, in this example the SSP will be the same because the turnout speed and the post turnout speed are the same.

Reference material only



### 10.3. Bi-directional Signalling and Turnouts

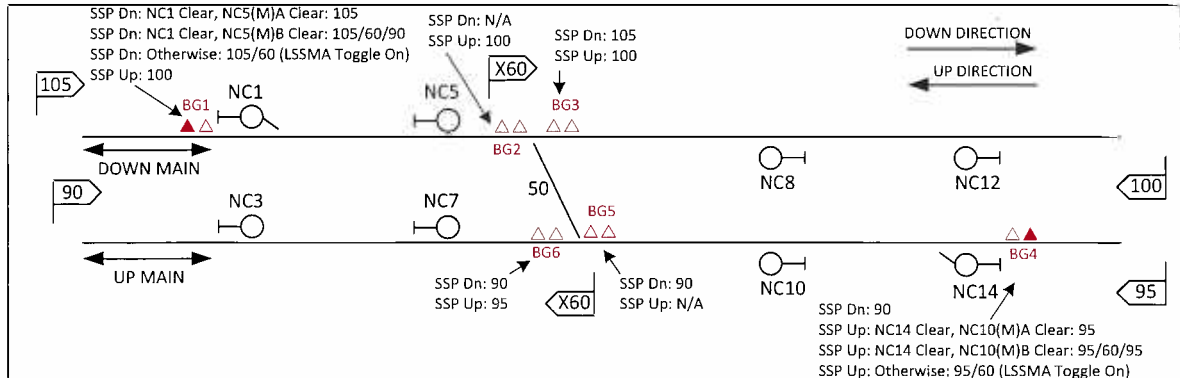

Figure 19

Figure 19 shows a bi-directional high risk turnout.

BG1 will initiate TSM in the down direction unless NC1 and NC5(M)A are clear. In the down direction, repositioning, speed updating and the toggling off of LSSMA will be performed by BG3 & BG5.

BG4 will initiate TSM in the up direction unless NC14 and NC10(M)A are clear. In the up direction, repositioning, speed updating and the toggling off of LSSMA will be performed by BG2 & BG6.

A down train travelling over BG2 must not receive an SSP packet, as it is possible that the train is braking to TSM. Similarly for an up train passing BG5.

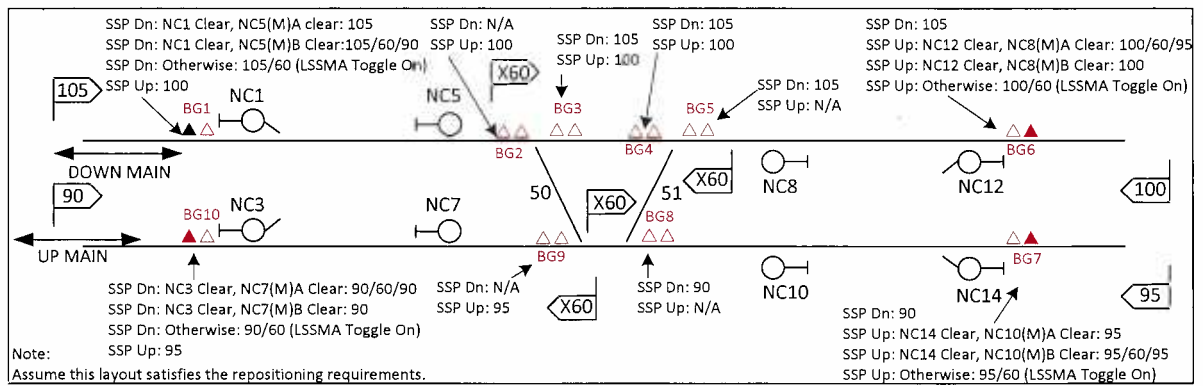

Figure 20

Figure 20 shows a high risk double crossover in a bi-directional area.

Reference material only

Note that there cannot be a balise group (providing updated speeds or toggling off LSSMA) on the Up Main between 50 and 51 points. If there was one there, the down SSP packet would include 90km/h for the updated speed profile after using NC5(M)B through 50 points reverse, however this same SSP packet would be read by a down train using NC7(M)A, where TSM would be applied for the high risk turnout through 51 points reverse. Similarly, the Up SSP packet would give a 95km/h updated speed profile for NC8(M)A, which would be wrong for movements using NC10(M)B.

Note that BG3 and BG4 are both required. BG3 is required to update the SSP to line speed as soon as possible after a down train has used NC5(M)A, in the case of it passing BG1 with NC5 at stop. Similarly for BG4 and NC8(M)B.

#### 10.4. Wrong Running Entry/Exit, Level Crossings and Turnouts

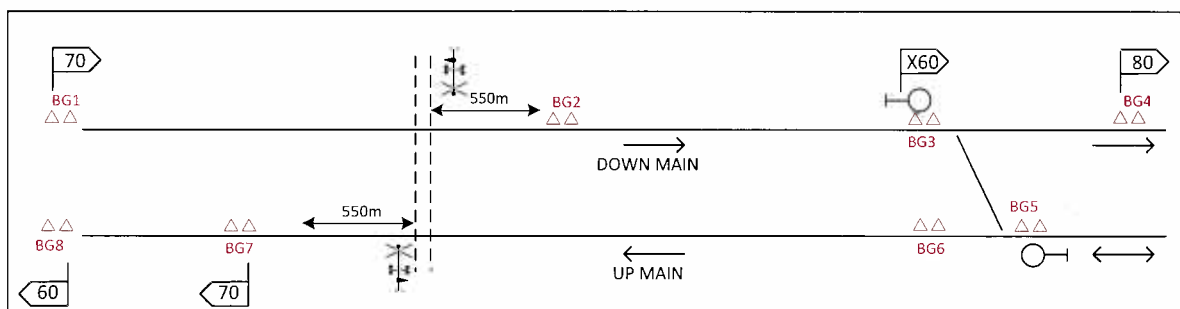

Figure 21

Figure 21 shows a level crossing (being a hazard for wrong running moves) and a low risk turnout. The crossover is signalled for down moves only.

BG3 is a wrong running entry balise group, and executes repositioning for up direction moves. It can also perform the first announcement of the wrong running hazard. In the down direction, it will be the second repositioning announcement.

BG2 is the second announcement of the wrong running hazard for up direction moves. In the down direction, it will be the first repositioning announcement.

BG4 is a speed sign balise group, and executes repositioning for down direction moves.

Reference material only

Reference material only

BG5 executes repositioning and updates the speed profile for down moves through the points reverse. For down wrong running moves along the Up Main, BG5 is a wrong running exit balise group.

BG6 is required to execute repositioning for up moves. This repositioning cannot be achieved by BG7, as this would place BG3 and BG2 inside the repositioning expectation window for the up direction turnout, potentially allowing BG2 to be ignored if BG3 was missed.

BG7 and BG8 are speed sign balise groups, and announce the wrong running level crossing for down moves along the Up Main.

### 10.5. Converging Junctions

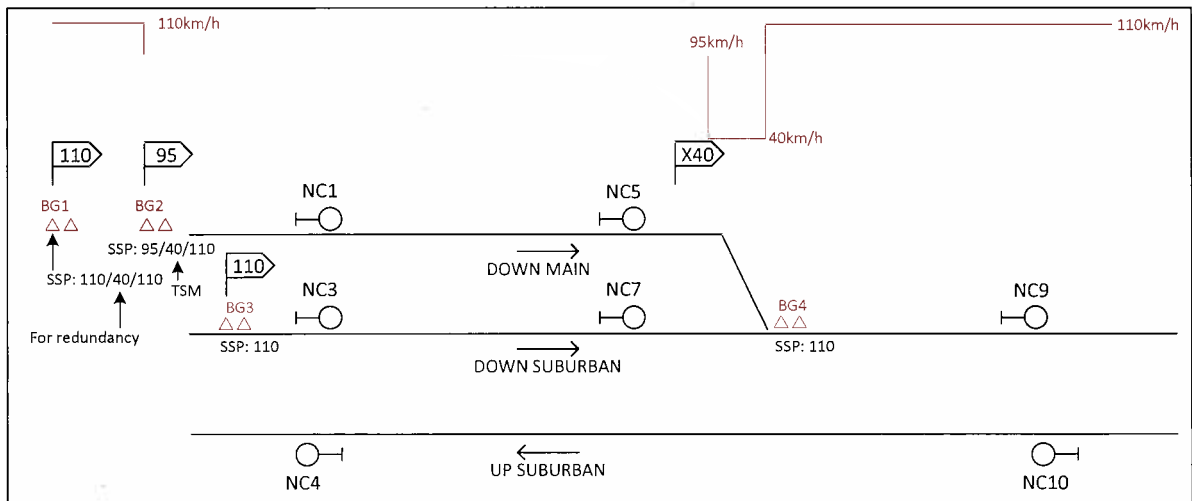

Figure 22

Figure 22 shows a high risk turnout at a converging junction.

As all trains approaching signal NC5 need to reduce their speed for the turnout, only fixed balise groups are necessary. The layout becomes a hybrid of a high risk speed reduction and a high risk turnout. In determining whether it is high risk, the criteria for high risk turnouts shall still apply, as the derailment risk is based upon the track geometry. LSSMA does not need to be toggled on, as TSM will always be applied. A balise group at the X40 speed sign is not required.

## 10.6. Speed Signs and Turnouts

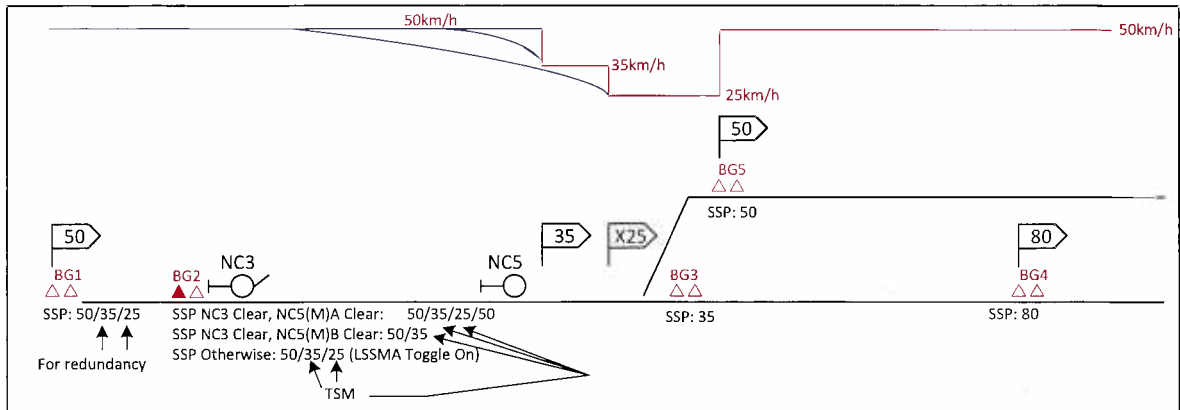

Figure 23

Figure 23 shows a high risk speed sign (35km/h) cascaded with a high risk turnout. The braking points need to be determined for each, with both having an approach speed of 50km/h. In this example, both functions need to be protected by AMS; the high risk speed sign is protected by TSM, initiated by BG2. The high risk turnout is (also) protected by BG2.

Note that the 35km/h speed sign cannot have its own balise group, as a train could be braking to a TSM.

If the turnout is deemed as low risk when compared to the high risk speed sign, no turnout protection is required provided it does not create additional hazard due to the fact that the turnout speed is not enforced as per Figure 24. Refer to the AMS Balise Arrangement for High Risk Location Design Guideline [Ref 4] for more details. BG2 of Figure 23 is not required instead BG1 of Figure 24 will initiate TSM for the high risk speed sign. BG3 of Figure 23 is also not required. The balise group prior to BG1 of Figure 24 (i.e. BG0) will provide redundancy in case BG1 is missed.

Reference material only

Reference material only

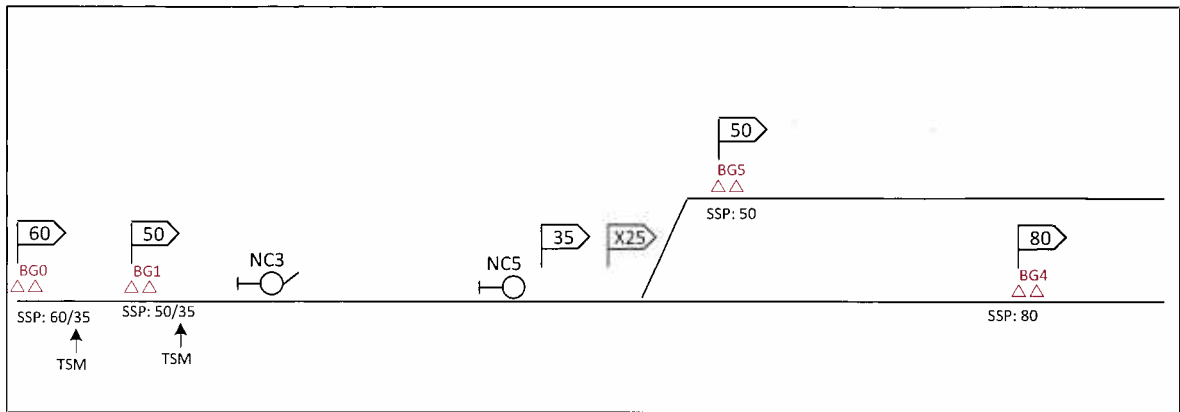

Figure 24

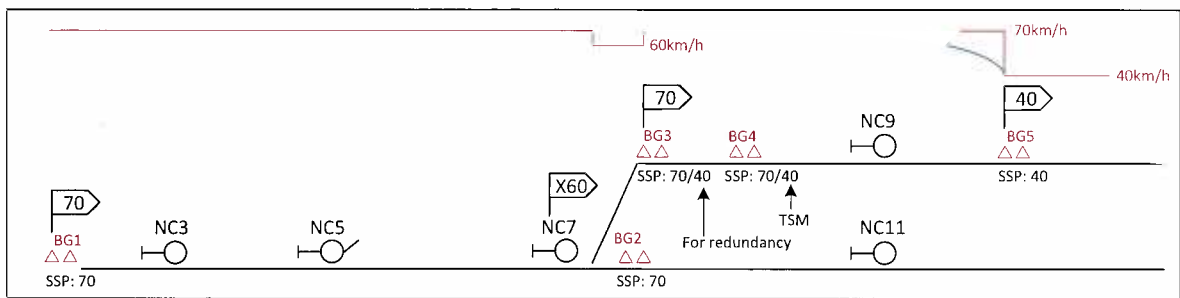

Figure 25

Figure 25 shows a high risk speed sign (40km/h) after a turnout. BG3 cannot be the initiator of TSM as it is a repositioning balise group, however it can provide the redundant TSM.

BG4 is required on the approach to the braking point to initiate TSM. It should be placed as close as possible to the braking point to allow the latest possible resetting of the confidence interval, which will minimise undue early braking during TSM.

BG2 is only required to satisfy the repositioning window requirement.

This same solution can be applied approaching a buffer stop or end of line after a turnout.

## 11. Examples of AMS Layouts

### 11.1. Hornsby

Figure 26 shows a simplified extract of Hornsby, which has conventional trainstops. The following describes the balise groups required. Refer to AMS Trackside Design Guideline [Ref 6] for more details on the balise naming convention.

Reference material only

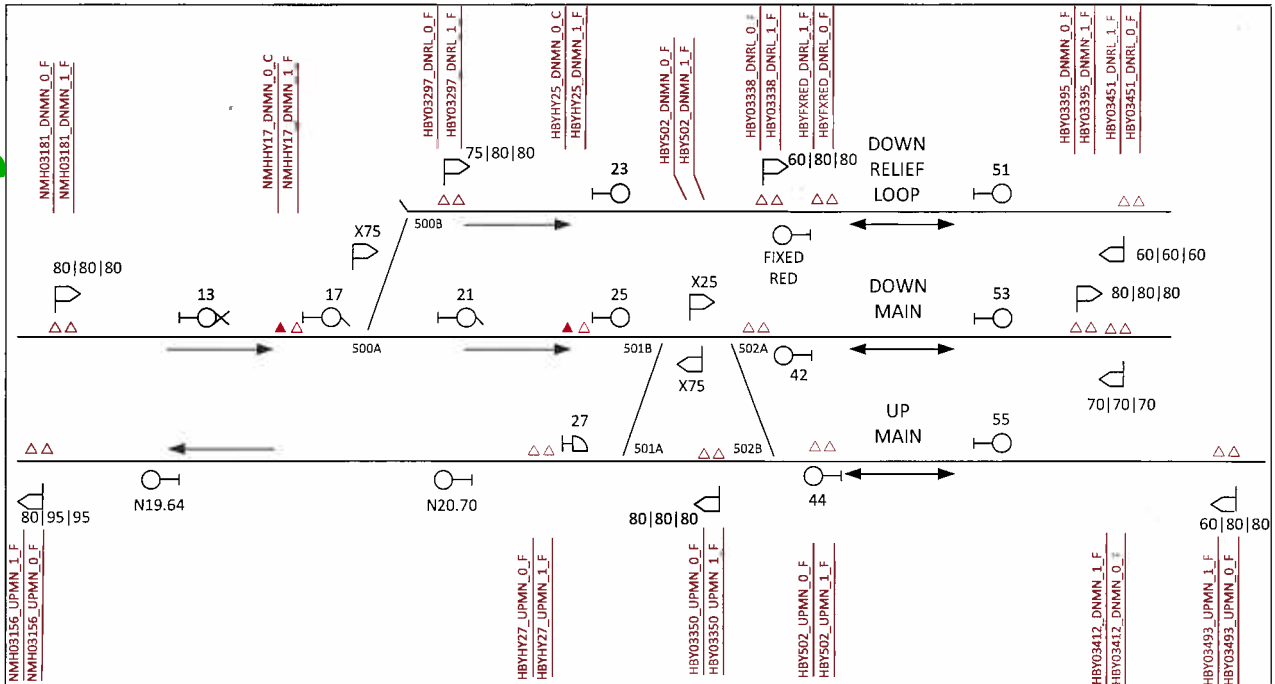

Figure 26

### 11.1.1. Speed Signs

All speed signs have a BG fitted, including those where the general speed is the only change, and including those where there is no change at all. Note that turnout speed signs do not have a BG fitted. All the speed signs in Figure 26 are low risk.

### 11.1.2. Turnouts and Repositioning

- 500A points (down direction)
  - low risk;
  - Repositioning announcement from BGs at NMH03181 and NMHHY17;
  - Repositioning execution from BGs at HBYHY25 and HBY03297.
- 500B catch points (up direction)
  - low risk;
  - No repositioning required, as only one destination is possible.
- 501A points (down direction)
  - low risk;
  - Repositioning announcement from BGs at NMH03156 and HBYHY27;

- Repositioning execution from BGs at HBY03350 and HBY502 (on Down Main).
- 501B points (up direction)
  - low risk;
  - Repositioning announcement from BGs at HBY03395 and HBY502 (on Down Main);
  - Repositioning execution from BGs at HBYHY25 and HBYHY27.
- 502B points (up direction)
  - low risk;
  - Repositioning announcement from BGs at HBY03493 and HBY502 (On Up Main);
  - Repositioning execution from BGs at HBY03350 and HBYHY25.
- 502A points
  - high risk;
  - Braking calculations indicate that the permitted point lies between HY17 and HY21 signals, thus the turnout protection BG will be at HY17 signal. (NMHHY17);
  - For a train using HY17(M)A, turning out through (the low risk) 500 points reverse, we don't want to toggle on LSSMA at NMHHY17. This will require the unusual requirement of inputting the HR (or equivalent) of a junction signal (low risk) turnout;
  - Assume an approach BG is required at the junction signal HY25 to minimise the operational impact. Refer to the AMS Approach Balise Group Selection and Position Design Guideline [Ref 3] for more details on the approach balise requirements;
  - Repositioning announcement from BGs at HBYHY25 only. Note that in this instance, the repositioning cannot be announced by two separate balise groups, as the BG in rear of HBYHY25 is NMHHY17, which is already announcing repositioning (for 500A);
  - Repositioning execution from BGs at HBY502 (Down Main) and HBY502 (Up Main).

### 11.1.3. Wrong Running Entry and Exit

- Down Relief
  - Up movements past the Fixed Red signal will use the BG at the speed sign for wrong running entry (HBY03338) provided the distance from the signal to the speed sign at 33.375km is greater than 100m but less than 160m or otherwise a dedicated BG may be required.
- Down Main
  - Up movements along the Down Main through 501 points normal will use the BG at HY25 signal for wrong running entry. (HBYHY25)
  - Up movements from the Up Main through 502 points reverse will also the BG at HY25 signal for wrong running entry. (HBYHY25)

Reference material only

- Note that this turnout BG (HBYHY25) can be combined with the wrong running function, as the front of a 160m train will pass over the BG before the rear of the train has entered the wrong running section.

- Up Main
  - Down movements along the Up Main will use the BG at HBY502 on the Down Main and the BG at HBY03350 on the Up Main for the wrong running exit. That is to say, the BG at HY27 (HBYHY27) will be the last BG in the wrong running section. Note that if HY27 happened to have a main route from it, then the wrong running exit BG would need to be at the signal, to update the static speed profile (allowed speed) to line speed from maximum SPA speed, as soon as the train passes the signal. A controlled BG will likely be required in order to supervise the correct speed applicable to both routes (i.e. through 501 points reverse and normal). This would also allow a train to change from SR to LS mode immediately after a turnback.

Reference material only



## 11.2. Leppington

Figure 27 shows a simplified extract of Leppington, which has conventional trainstops. The following describes the balise groups required. Refer to AMS Trackside Design Guideline [Ref 6] for more details on the balise naming convention.

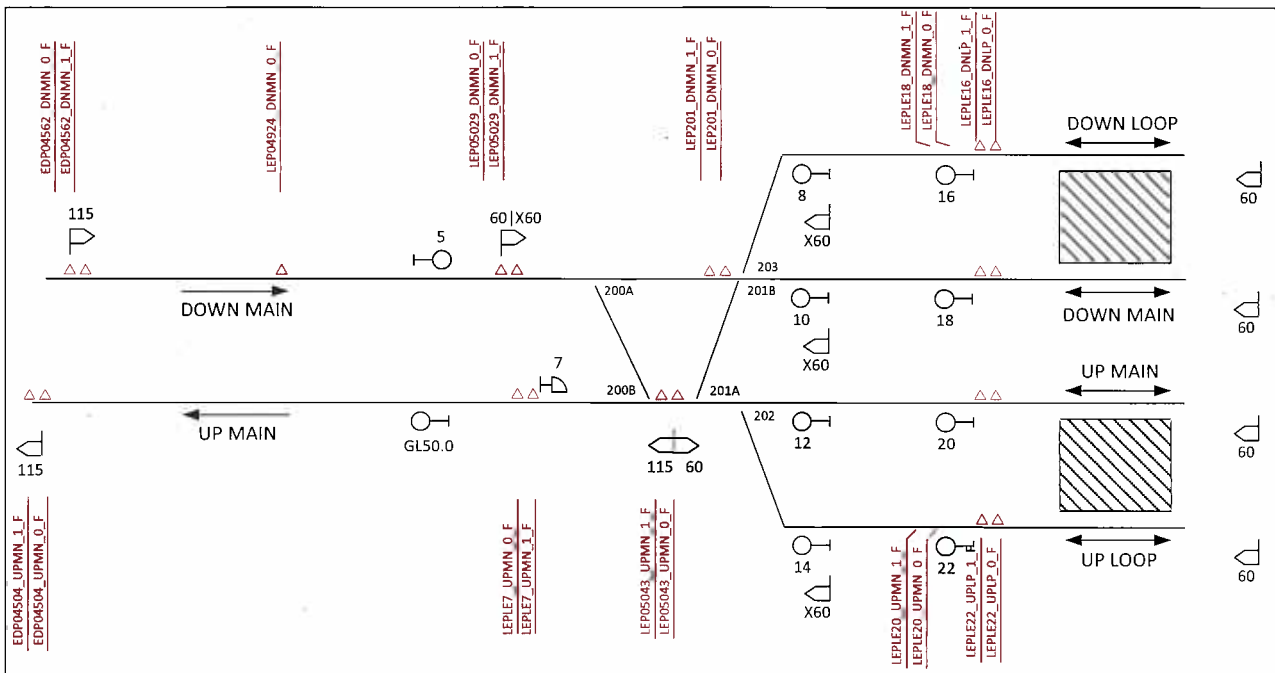

Figure 27

### 11.2.1. Speed Signs and Calibration

All speed signs have a BG fitted. Note that turnout speed signs do not have a BG fitted.

- 115km/h down speed sign at 45.620km on the Down Main (EDP04562)
  - low risk.
- 60km/h down speed sign at 50.293km on the Down Main (LEP05029)
  - high risk;
  - TSM will be initiated by the speed sign balise group in rear, i.e. by EDP04562;
  - Without any calibration balises, initial calculations show:

Reference material only

\* Permitted point (i.e. the point where the train needs to start braking to avoid a speed warning being displayed) would be at 1037m in rear of the 60km/h speed sign;

\* 'Flatline' point (i.e. the point where the train needs to reduce to target speed without a speed warning being displayed) would be at 344m in rear of the 60km/h speed sign;

- One of the reasons that the permitted point and flatline point are so far in rear is due to the confidence interval being large because of the long distance (4.673km) from the previous balise. These long distances from the permitted and flatline points to the target point could impact train running times;

- The confidence interval can be reduced by installing a calibration balise (LEP04924) at a point before the permitted point. In this example, with a calibration balise installed at a point greater than 1037m in rear of the 60km/h speed sign, e.g. 1050m in rear, initial calculations show:

\* Permitted point at 865m in rear of the 60km/h speed sign;

\* Flatline point at 160m in rear of the 60km/h speed sign.

- 115km/h up speed sign at 50.430km on the Up Main (LEP05043)
  - low risk.
- 60km/h down speed sign at 50.430km on the Up Main (LEP05043)
  - low risk;
  - Note that this speed sign BG function and the one above can be combined into the one BG.

### 11.2.2. Turnouts and Repositioning

- 200A points
  - Low risk;
  - Upon initial inspection, this turnout appears to high risk, as the approach speed (115km/h) is 55km/h higher than the turnout speed. However, TSM will be applied to the high risk 60km/h speed sign, so the approach speed to the turnout is deemed to be 60km/h. This is an example of cascading functions where protecting one removes the need to protect the other.

Reference material only

Reference material only

- Repositioning announcement from BGs at EDP04562 and LEP05029, noting that single balises won't normally be used for this purpose;
- Repositioning execution from BGs at LEP05043, LEP201.
- 200B points
  - Low risk;
  - Repositioning announcement from BGs at LEPLE20 or LEPLE22, and LEP05043. Note that LEPLE16 and LEPLE18 will not announce repositioning, as they will already be announcing repositioning for 201B points;
  - Repositioning execution from BGs at LEPLE7 and LEP05029.
- 201A points
  - Low risk;
  - Repositioning announcement from BGs at LEP05043 and LEPLE7;
  - Repositioning execution from BGs at LEPLE16, LEPLE18, LEPLE20, and LEPLE22.
- 201B points
  - Low risk;
  - Repositioning announcement from BGs at LEPLE16 or LEPLE18;
  - Repositioning execution from BGs at LEP201 and LEP05043.
- 202 points
  - Low risk;
  - Repositioning announcement from BGs at LEP05043 and LEPLE7;
  - Repositioning execution from BGs at LEPLE16, LEPLE18, LEPLE20, and LEPLE22.
- 203 points
  - Low risk;
  - Repositioning announcement from BGs at LEP201B or LEPLE7 and LEP05043;
  - Repositioning execution from BGs at LEPLE16 and LEPLE18.

### 11.2.3. Wrong Running Entry and Exit

- Down Main
  - Up movements through 200 points reverse from the Up Main and Up Loop will use LEP05029 for wrong running entry.
  - Up movements through 201 points normal from the Down Main and Down Loop will use LEP201 for wrong running entry
- Up Main

- Down movements will use LEPLE7 for wrong running exit.

#### 11.2.4. Mode Change

When a down train terminates in a platform and the driver is required to change ends, the up movement the train will be starting in SR mode. Mode Change balise groups will be required at each of the platform up starting signals to order a mode transition to LS mode.

- LEPLE16, LEPLE18, LEPLE20 and LEPLE22.

Reference material only